

Fitting Instructions

Revo Intercooler Kit 2.3 Focus ST MK4 EcoBoost

Fitting Difficulty



Dealer Fit Recommended

Contents

Description	
Revo Intercooler	1
Revo Inlet Hose	1
Revo Outlet Hose	1
Revo Upper Brackets	2
Revo Upper Bracket Retainer 1	1
Revo Upper Bracket Retainer 2	1
Revo Lower Brackets	2
M6x12 Button Head Stainless Steel Bolts	10
M6 Stainless Steel Flat Washers	10
70-90mm Stainless Steel Hose Clamp	2
50-70mm Stainless Steel Hose Clamp	2

Recommended Tools

Tools	Size
Ratchet	
Sockets	8, 10, 15, 19mm
Wrench	10mm
Torx Bits	T30
Hex Bits	4mm
Panel Clip Pliers	
Trim Removal Tools	



Before starting, please ensure that the engine is cool and the battery is disconnected. Engine temperatures can remain high for a substantial amount of time after use.

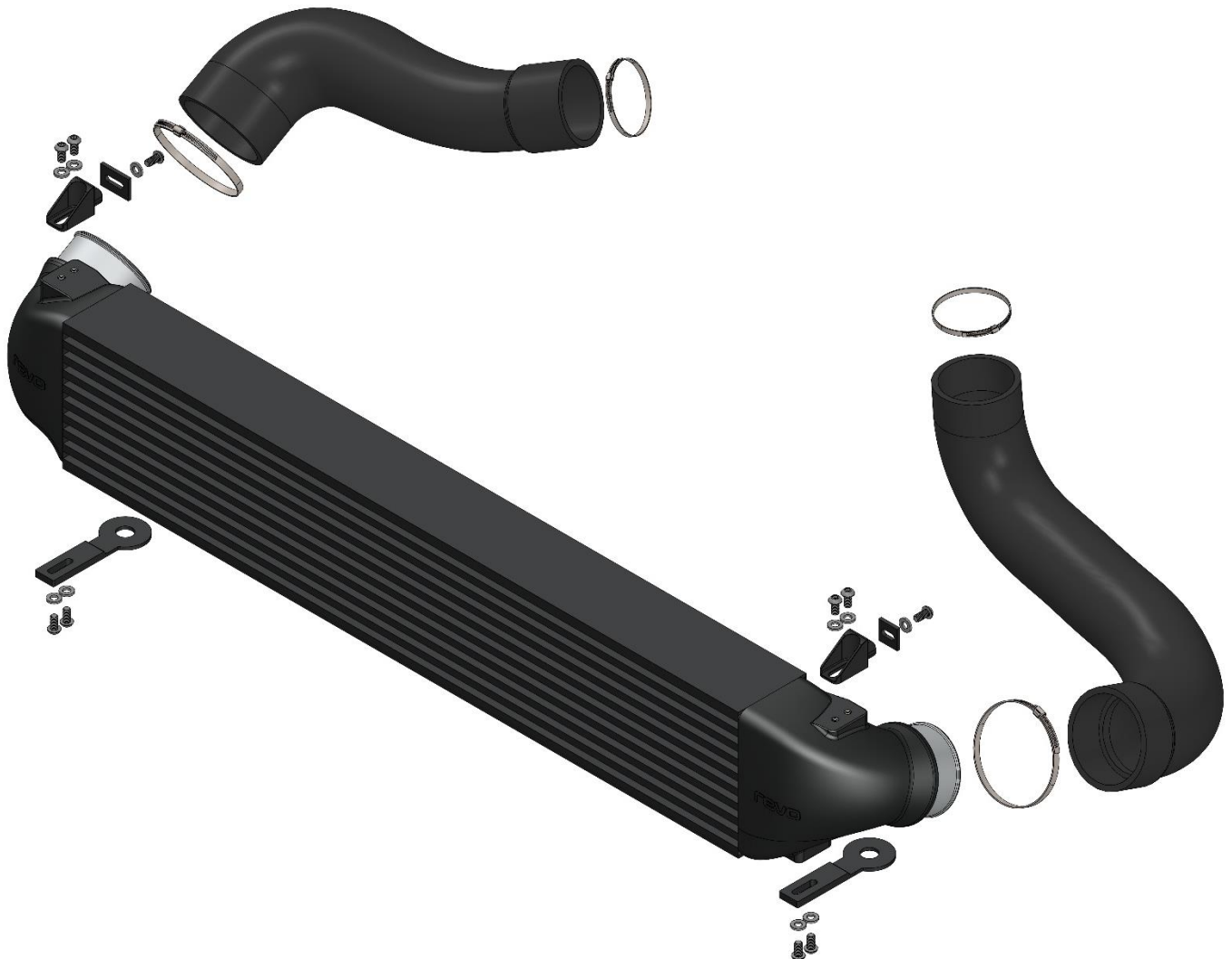

Fitting Instructions

Revo Intercooler Kit 2.3 Focus ST MK4 EcoBoost

Fitting Difficulty



Dealer Fit Recommended

 Installation was performed on a UK-spec. MK4 Focus ST. Installation on other vehicles will be similar but may not be exact.

- 1 Raise the vehicle to gain access to the underside. Remove the 17 x T30 screws from the undertray. Remove the 5 lower bumper bolts with a 10mm socket



- 2 Remove the 2 front wheels using a 19mm socket. Remove the 3 x T30 inner fender liner screws, as well as the 3 inner fender liner clips with panel clip pliers. Carefully pull the inner fender liner back to gain access behind the bumper cover. Repeat on the opposite side of the vehicle



- 3 Remove the now-exposed plastic bumper clip on each side of the bumper cover with panel clip pliers

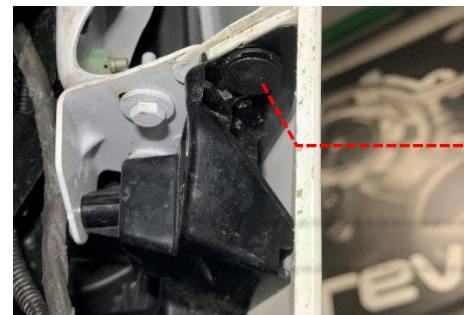

- 4 Disconnect the electrical connector and 2 wire routing clips shown

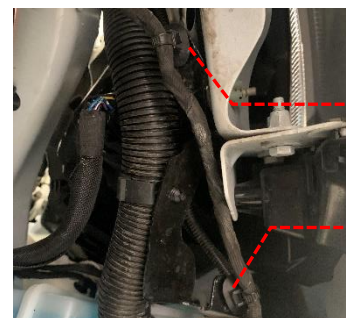

Fitting Instructions

Revo Intercooler Kit 2.3 Focus ST MK4 EcoBoost

Fitting Difficulty



Dealer Fit Recommended

- 5 At the top of the bumper cover, remove the 6 bolts shown with a 10mm socket and the 2 plastic clips with panel clip pliers

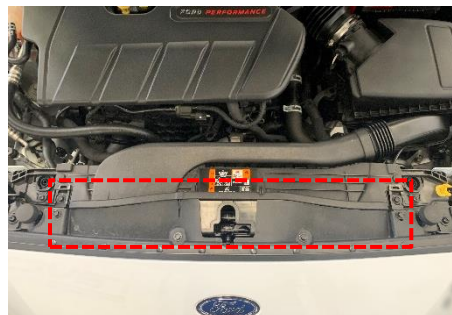

- 6 Using plastic trim tools, carefully pull the bumper cover sides outward to disconnect the cover from the chassis clips. Remove the bumper cover and set it aside, out of the work area

Note: The bumper cover retainer clips break easily, disconnect the bumper cover gently

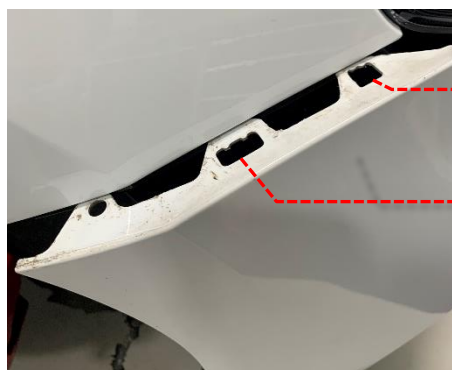

- 7 Remove the 2 plastic clips from the front intake ducting with panel clip pliers. Unclip the airbox feed and set the duct aside, out of the work area

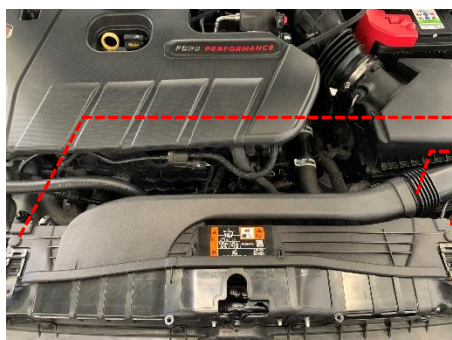

- 8 Disconnect the bonnet release cable and remove the cable from the routing clips as shown

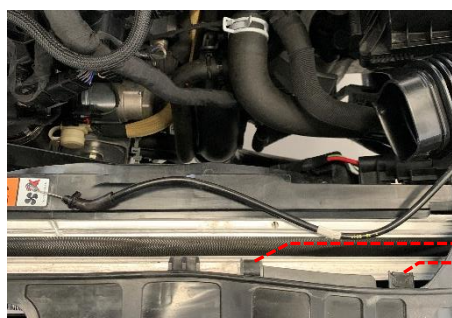

Fitting Instructions

Revo Intercooler Kit 2.3 Focus ST MK4 EcoBoost

Fitting Difficulty



Dealer Fit Recommended

- 9 Remove the 2 x T30 screws from the headlight, disconnect the headlight electrical connector and remove the headlight assembly. Repeat on the opposite side of the vehicle

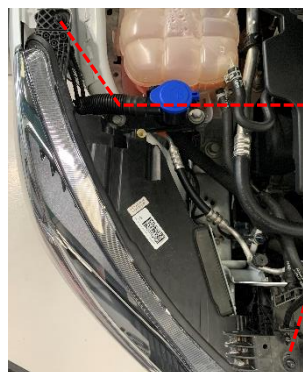

- 10 Using panel clip pliers, remove the 4 plastic clips shown from the top of the upper radiator duct

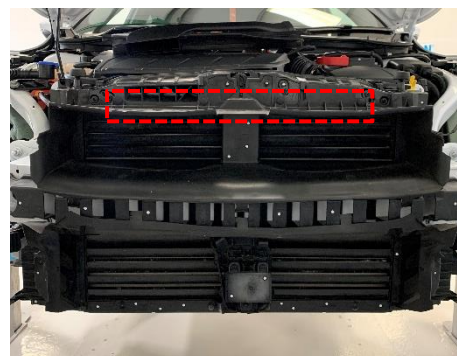

- 11 Push in the retaining clips on both sides of the upper radiator duct and remove the duct by lifting it up and away from the vehicle. Set the duct aside, out of the work area

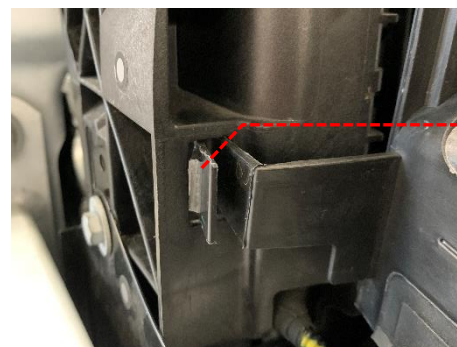

- 12 Disconnect the ambient temperature sensor electrical connector and the 2 wire routing clips. Carefully remove the lower ducting and set it aside, out of the work area

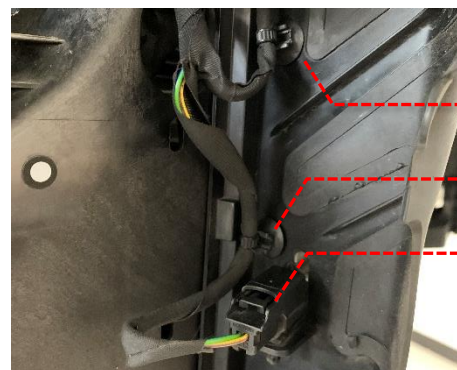

Fitting Instructions

Revo Intercooler Kit 2.3 Focus ST MK4 EcoBoost

Fitting Difficulty



Dealer Fit Recommended

- 13 Remove the 4 bolts (2 per side) and 8 nuts (4 per side) from the crash bar, using 10mm and 15mm sockets. Slide the crash bar forward to remove it from the vehicle

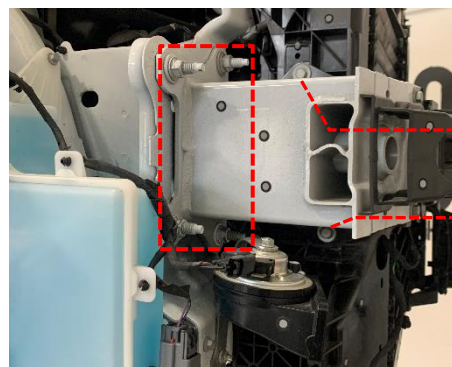

- 14 Disconnect the electrical connector shown, located behind the heat exchanger core support

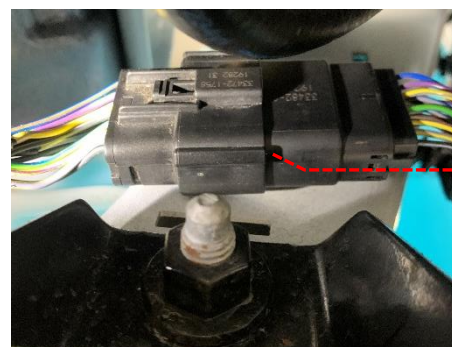

- 15 Remove the intercooler inlet hose from the vehicle by unclipping the retaining clip at the intercooler, as shown, and loosening the hose clamp with an 8mm socket. Repeat for the intercooler outlet hose, but do not remove the outlet hose (it will be easier to remove from the vehicle at a later step)

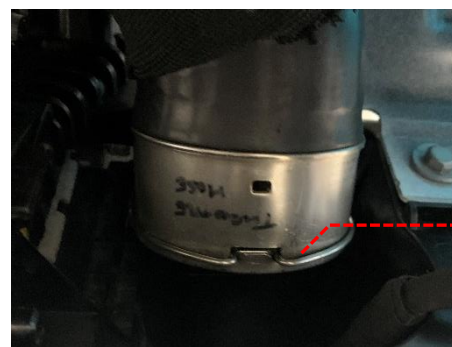

- 16 Remove the 4 bolts from the bottom of the heat exchanger core support using a 10mm socket

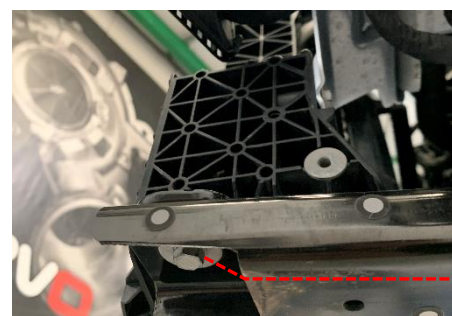

Fitting Instructions

Revo Intercooler Kit 2.3 Focus ST MK4 EcoBoost

Fitting Difficulty



Dealer Fit Recommended

- 17 Firmly support the bonnet and disengage the bonnet support bar. Support the heat exchanger core support from the underside and remove the 2 bolts at the top of the core support, using a 10mm socket. Remove the intercooler outlet hose, if it was not removed during the previous steps

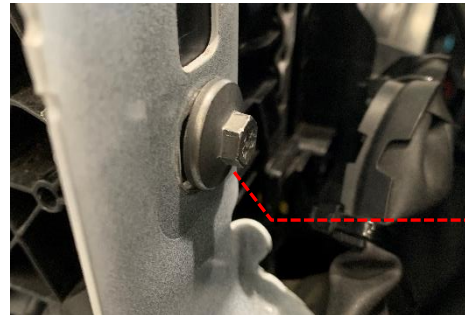

- 18 Remove the 1 x T30 screw from the radiator support clip, press the sides of the clip and slide it toward the engine. Repeat on the opposite side of the vehicle

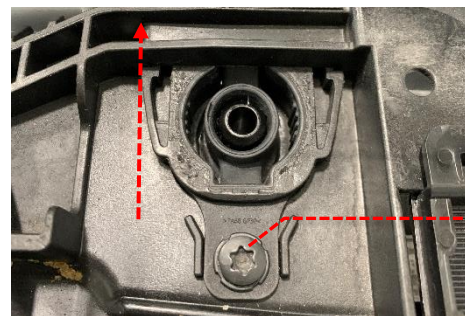

- 19 Lift the heat exchanger stack (intercooler, condenser, radiator) up to remove the stack from the core support. Remove the core support, set it aside and carefully support the heat exchanger stack from the bottom



- 20 Remove the intercooler by compressing the integrated clips on each side of the unit, tilt the intercooler away from the heat exchanger stack and lower the unit directly downward



Fitting Instructions

Revo Intercooler Kit 2.3 Focus ST MK4 EcoBoost

Fitting Difficulty



Dealer Fit Recommended

- 21 Install the Revo upper brackets onto the Revo intercooler using 4 of the supplied bolts/washers and a 4mm hex socket. Do not tighten the bolts at this time, ensure the top brackets can slide within their slots. Support the Revo intercooler from the bottom and install it into the radiator clip provisions. Using 2 more supplied bolts/washers and a 4mm hex socket, install the Revo upper bracket retainers on the outside of the radiator flanges as shown

Note: The Revo upper bracket retainers are not identical, be sure to install the smaller retainer (#5) on the inlet side of the Revo intercooler

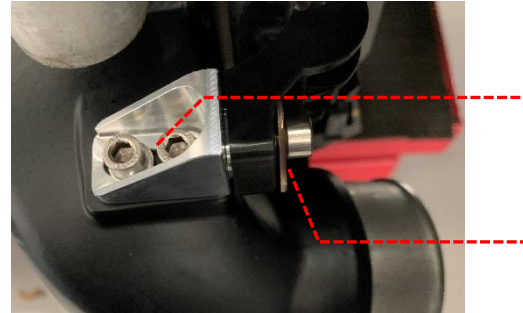

- 22 Install the Revo lower brackets onto the Revo intercooler using the remaining 4 bolts/washers supplied and a 4mm hex socket. Adjust the Revo upper/lower brackets as required and tighten all bracket bolts to 8 Nm (71 in.-lbs). Install the Revo outlet hose with the 2 provided clamps into the engine bay, but do not tighten clamps at this time

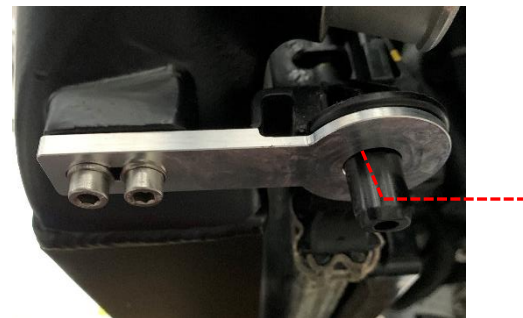

- 23 Lift the heat exchanger stack and reinstall the core support. Check that the Revo intercooler is adjusted correctly and does not interfere with any parts once the core support is reinstalled. Remove the core support and readjust the Revo intercooler position to eliminate any interferences, if required

- 24 Once the Revo intercooler has been adjusted to clear all surrounding parts, install the Revo inlet hose with the remaining 2 hose clamps. Use an 8mm socket to tighten all 4 hose clamps on both Revo hoses. Reinstall all OE parts back onto the vehicle, following the reverse order of removal. Follow any factory torque specification during reinstallation of OE parts. Check all sensors/electrical connectors are reconnected. Also check the bonnet release cable is reconnected

Note: Be sure not to close the bonnet before reconnecting the release cable

Test drive the vehicle to ensure vehicle performs correctly and there are no leaks/part interference during operation. Your installation is now complete!

Fitting Instructions

Revo Intercooler Kit 2.3 Focus ST MK4 EcoBoost

Fitting Difficulty



Dealer Fit Recommended

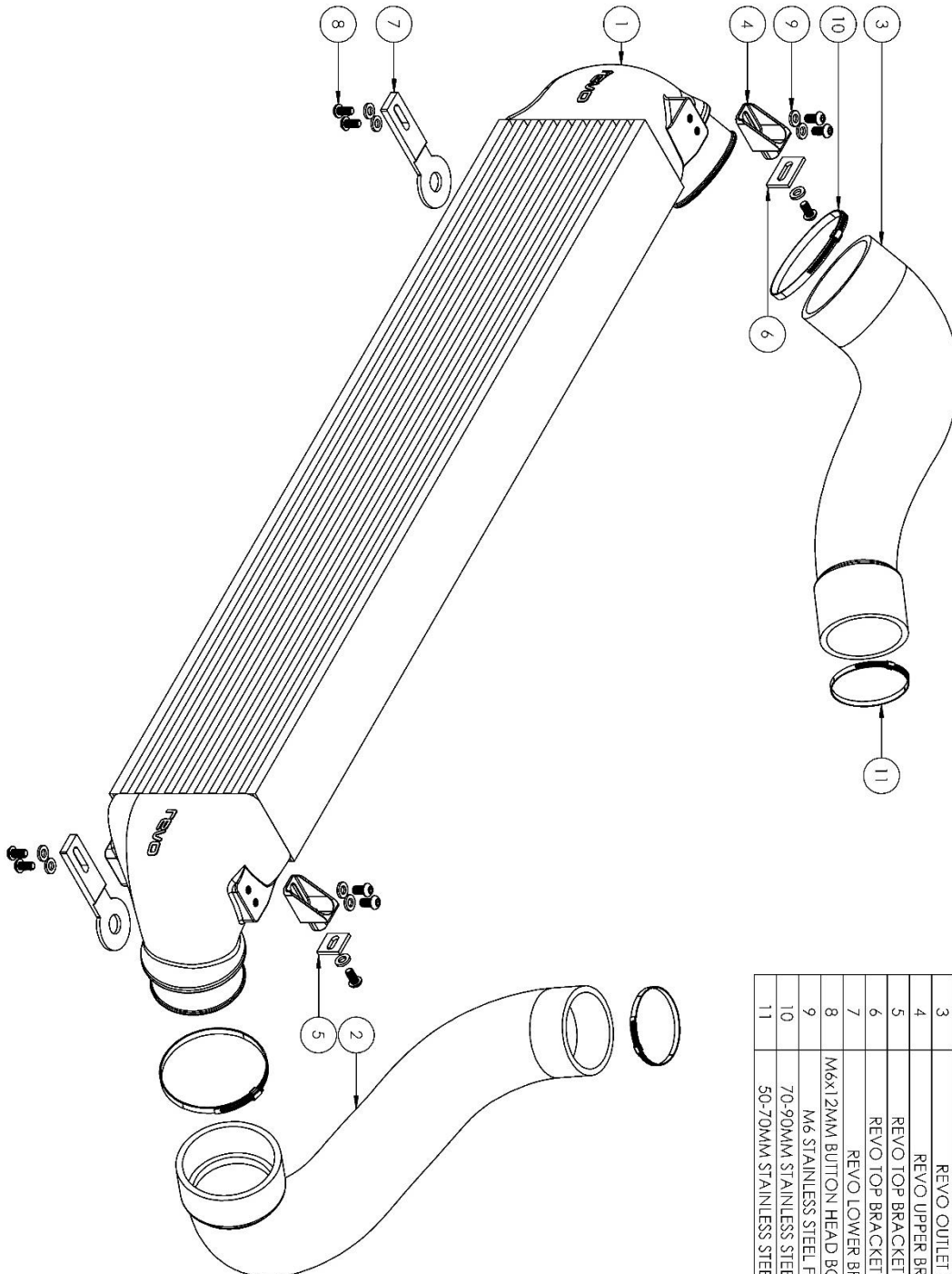

ITEM NO.	DESCRIPTION	QTY.
1	REVO INTERCOOLER	1
2	REVO INLET HOSE	1
3	REVO UPPER BRACKET	2
4	REVO LOWER BRACKET	2
5	REVO TOP BRACKET RETAINER 1	1
6	REVO TOP BRACKET RETAINER 2	1
7	M6x12MM BUTTON HEAD BOLT STAINLESS STEEL	10
8	M6 STAINLESS STEEL FLAT WASHER	10
9	70-90MM STAINLESS STEEL HOSE CLAMP	2
10	50-70MM STAINLESS STEEL HOSE CLAMP	2
11		